

TURBISOL 56/2 blowing machine - Carding shaft with adjustable blades

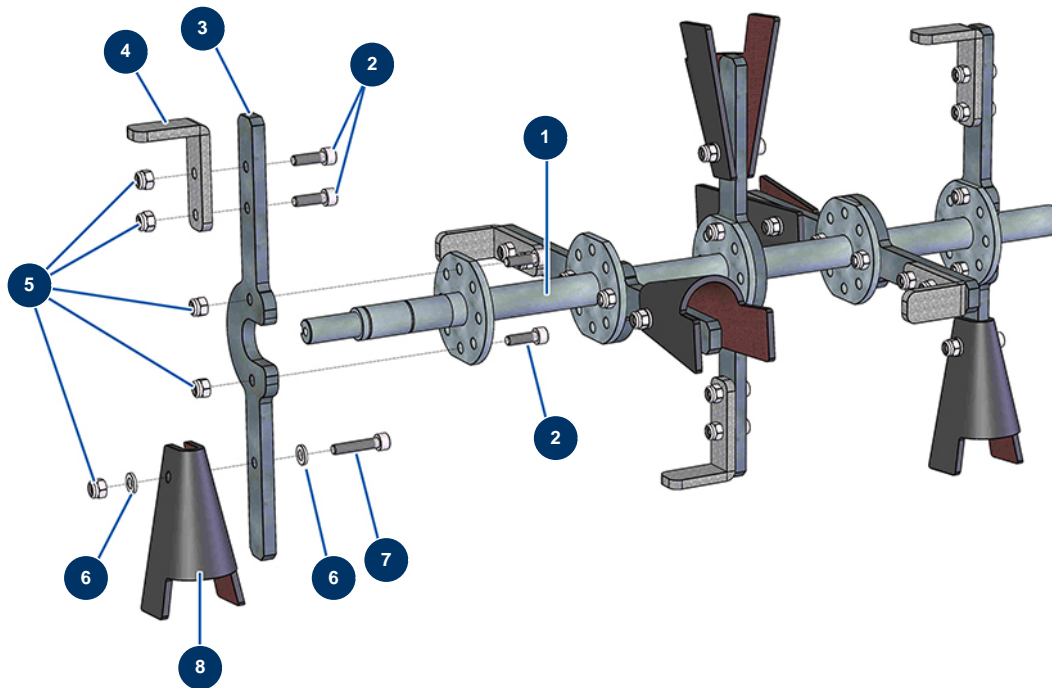

Détails des pièces

Pos.	Référence	Désignation
1	C22864	Single 5-blades mixing shaft for TURBISOL 56 Evo2, 112 & 164
2	90996	6 x 20 inox cylindrical head screw
2	90996	6 x 20 inox cylindrical head screw
3	C22867	TURBISOL 164 straight carding paddle
4	C20692	TURBISOL mixing claw, 45 mm
5	14217	M 6 nylstop inox nut
6	80259	Ø 6 medium washer
6	80259	Ø 6 medium washer
7	90153	6 x 30 cylindrical head screw
8	11906	Blowing machine mixer foam-rubber square