

POLYMAIR 6 HVLP spraying system - Turbine

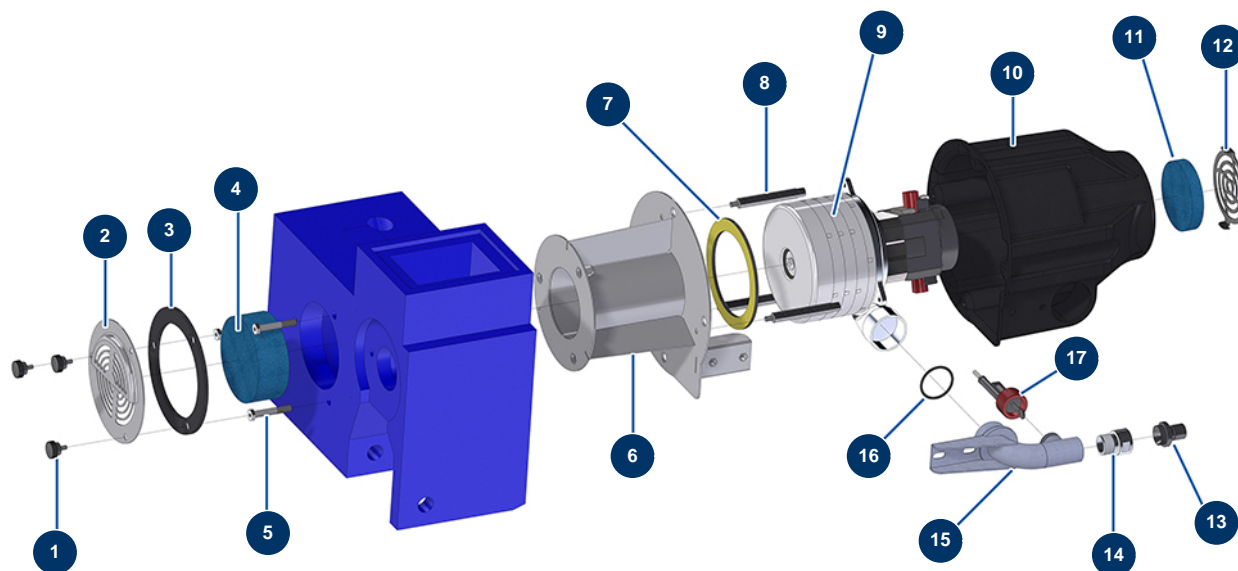

Détails des pièces

Pos.	Référence	Désignation
1	12261	Ø22 M5 x 10 outer threaded plastic thumb wheel
2	11791	POLYMAIR ventilation grid
3	13996	POLYMAIR 2017 ventilation grid gasket
4	13982	POLYMAIR 2017 foam filter
5	M10577	POLYMAIR 2017 assembling screw
6	C21979	POLYMAIR 2017 turbine support
7	13990	EOLE T5 2017 turbine bearing seal
8	M10552	EOLE T5 2017 turbine fixation spacer
9	13835	5-stage turbine - 230V
10	13992	POLYMAIR 2017 turbine crankcase
11	11931	Blowing machine air filter Ø 90
12	C21941	T2 2017 ventilation grid
13	M10557	EOLE T2/T5 2017 male quick-connector

Pos.	Référence	Désignation
14	1022230	Turbine outlet air exhaust valve
15	C21985	POLYMAIR 2017 air outlet elbow
16	1001269	O-ring 38 x 3
17	13999	POLYMAIR 2017 air flow rate controller