

X-PRO D80 spraying machine - Pump (facade)

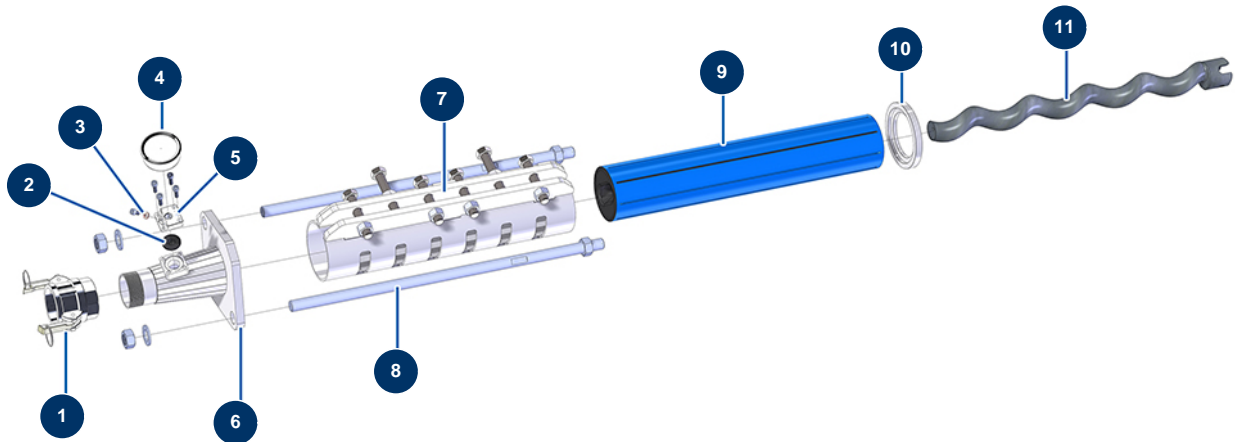

Détails des pièces

Pos.	Référence	Désignation
1	12364	2" camlock steel coupling, inner threaded 2" - CP 60
2	12126	MIXPRO 14 pump head manometer membrane
3	12765	Copper seal for JETPRO 80 pump nose
4	80070	Axial manometer 1/4" conical oil 50 mm 0 to 60 bar
5	M10079	MIXPRO 14 cage cover
6	C20500	Pump head clamp for 2L6 stator - C.P 60
7	C20766	MAP10 clamping jacket - CP60 V17
8	M10281	595 mm fastening tie rod for CP 60
9	MI3F00503800	EUROPRO JUMBO SX 8 slits pump stator
10	M10361	CP60 stator centring ring
11	MI7009008800	EUROPRO JUMBO pump rotor