

X-PRO D80 spraying machine - Bodywork

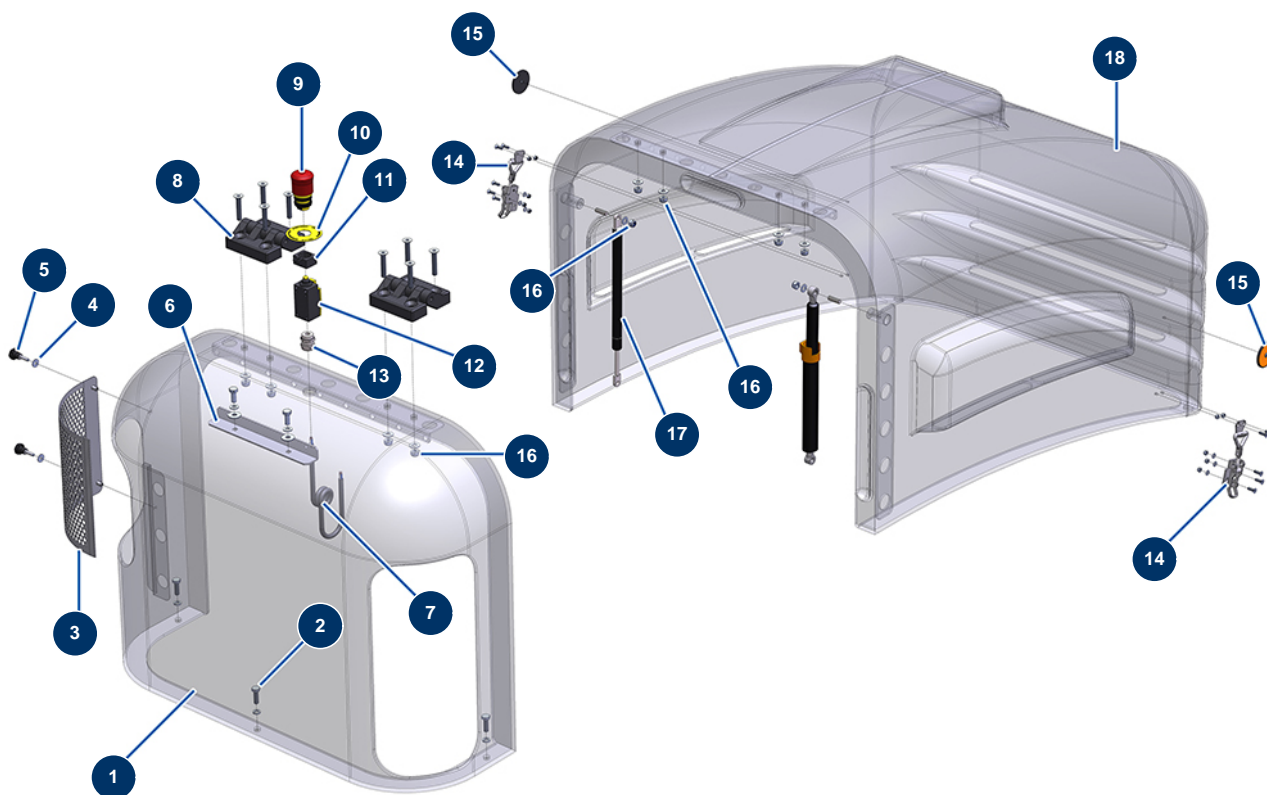

Détails des pièces

Pos.	Référence	Désignation
1	14413	CP 60, 70, 80 & 120 small model fixed bonnet
2	11544	THEF 8 x 25 screw
3	C20986	CP 60 hood removable lateral grid
4	30290	ø 5 large washer
5	12396	Plastic thumb wheel M5 x 20
6	C20866	Removable angle for hood reinforcement CP60 V17
7	11973	Electrical cable H05VVF 2x1 / sold by the meter
8	12797	Hood hinge - C.P 60
9	90727	Hook emergency stop button - CP 60
10	12824	Round sticker "Emergency stop" for CP 60
11	12664	Security switch adapter / emergency stop button - C.P 60
12	12663	Push safety switch - C.P. 60
13	80448	M 20 waterproof cable gland

Pos.	Référence	Désignation
14	13111	Large hood locking adjustable locking clamp - C.P 60
14	13111	Large hood locking adjustable locking clamp - C.P 60
15	12361	Round & orange reflector - C.P 60
15	12361	Round & orange reflector - C.P 60
16	90127	M 8 nylstop nut
16	90127	M 8 nylstop nut
16	90127	M 8 nylstop nut
17	80209	Mobile hood gas spring - C.P 60
18	14412	CP 60, 70, 80 & 120 large model mobile bonnet