

X-PRO D80 spraying machine - Chassis

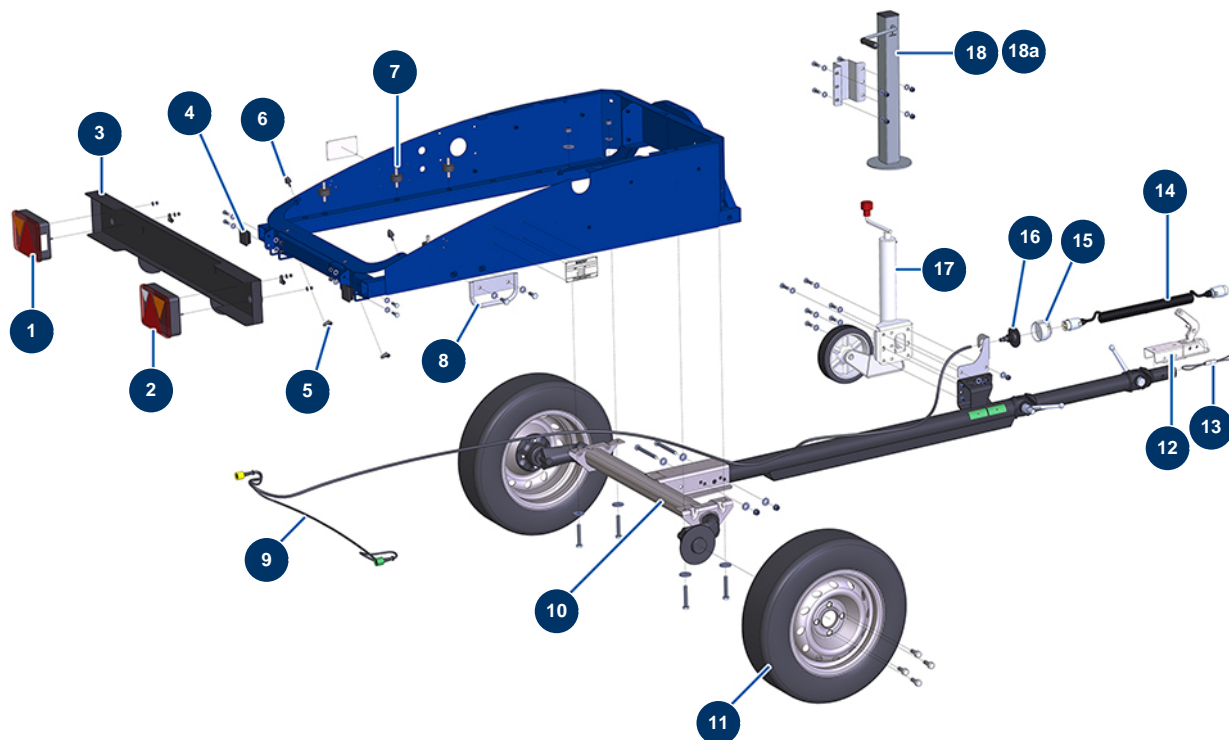

Détails des pièces

Pos.	Référence	Désignation
1	12802	Complete left rear lights - C.P 60
2	12803	Complete right rear lights - C.P 60
3	C22019	CP60 2017 light plate chassis
4	12665	Plastic end cap for 50 x 50 mm tube
5	12395	ø 10 cable collar - CP 60
6	14216	ø 20 x 24 M6 conical stop
7	30150	Silentbloc ø 40 x 20 M10
8	C20976	Chassis docking support CP 60 version 7.13
9	12801	Complete lighting wiring harness 3.5 m - C.P 60
10	13839	Axle 750 kg hub 98x4 EAB 715 AL-KO - CP 60
11	14885	Complete wheel 155/80 R13 98x4 - CP 60
12	12877	TZ sprocket Ø 50 ball towing head - C.P 60
13	14326	Headstock safety cable AK160 ø 50 nut PA - CP 60

Pos.	Référence	Désignation
14	13284	7-pin metal male sockets 2.5 m x 2 spiral extender - C.P 60
15	13282	Lighting metal 7-pin female socket - C.P 60
16	13283	Lighting metal 7-pin female socket foam rubber gasket - C.P 60
17	13905	Automatic jockey wheel 500 Kg - CP 60 & 80
18	14547	Stand option - X-PRO D60 to 85
18a	13106	Retractable stand - CP 60