

X-PRO D80 V2 spraying machine - Motorisation

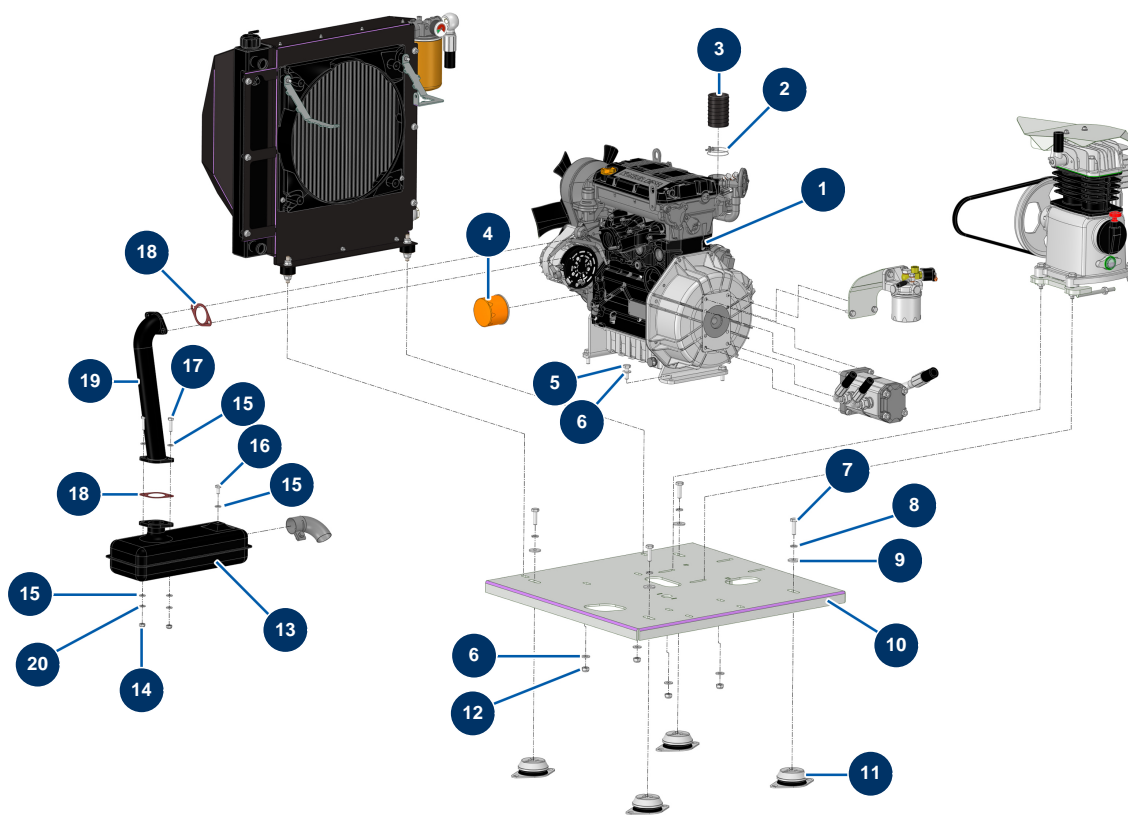

Détails des pièces

Pos.	Référence	Désignation
1	13971	Diesel motor KOHLER KDW 1404 gear
2	12723	Double wire clamp \varnothing 56 x 65 - CP 60
3	12538	PVC GAS sheath \varnothing 50 by the metre - C.P 60
4	80334	FOCS LDW1003, KDW1003 motor oil filter
5	30258	THEF 10 x 30 screw
6	80261	\varnothing 10 inox medium washer
6	80261	\varnothing 10 inox medium washer
7	20766	7
8	12462	Grower washer \varnothing 12
9	30294	\varnothing 12 inox large washer
10	C23843	10
11	20786	Silentbloc for X-PRO D60, D140 motor plate
12	60013	M 10 nylstop nut

Pos.	Référence	Désignation
13	30539	CP 60 diesel motor exhaust
14	90440	M 8 zinc plated nut
15	30256	∅ 8 inox narrow washer
15	30256	∅ 8 inox narrow washer
15	30256	∅ 8 inox narrow washer
16	30295	THEF 8 x 16 screw
17	30205	THEF 8 x 30 screw
18	30793	LOMBARDINI motor exhaust pipe gasket - C.P 60
18	30793	LOMBARDINI motor exhaust pipe gasket - C.P 60
19	C23848	19
20	80269	Grower washer ∅ 8